

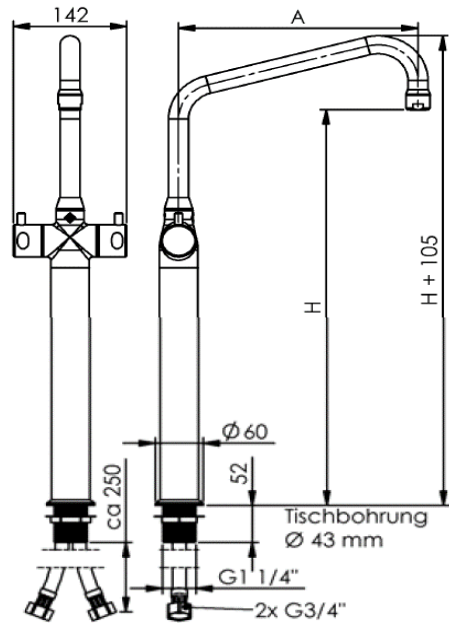

Robinet col de cygne 3/4" monotrou mélangeur **Inox 316L**

Réf: 0210795-I



Fabrication Allemande



- Mélangeur à commande céramique 1/4 tour
- Corps et tête de robinet en inox 316L
- Col de cygne avec système anti-goutte
- Option : Assemblage par le dessus
- Poignée Thermo-isolante

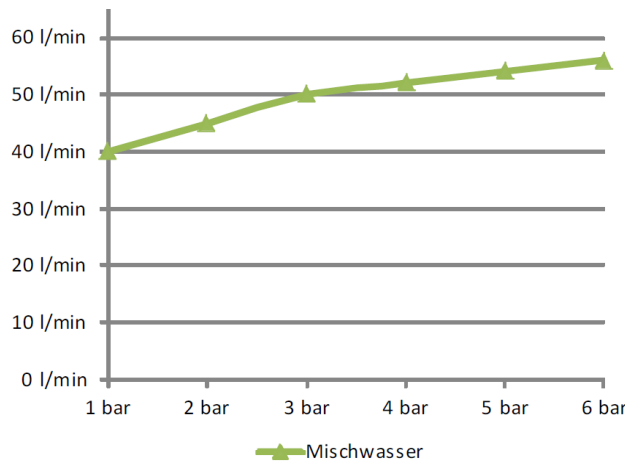

Référence EPCI	0210795-I
Longueur de col de cygne	500 mm
Hauteur totale	660 mm
Hauteur sous col de cygne	555 mm
Raccordement	G3/4
Débit d'eau	50 L (3 Bar)
Garantie	15 ans (corps inox)
Finition	Inox 316 L MAT