

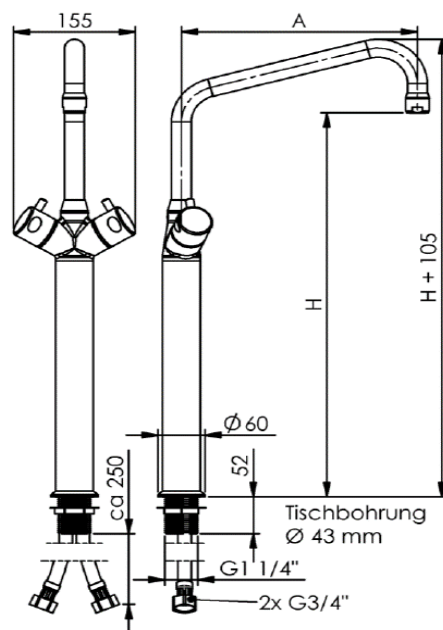

Robinet col de cygne 3/4" monotrou mélangeur  
Inox 316L

Réf: 0210514-I



Fabrication Allemande



- Mélangeur à commande 1/4 tour
- Corps et tête de robinet en inox 316L
- Col de cygne avec système anti-goutte
- Option : Assemblage par le dessus
- Poignée Thermo-isolante

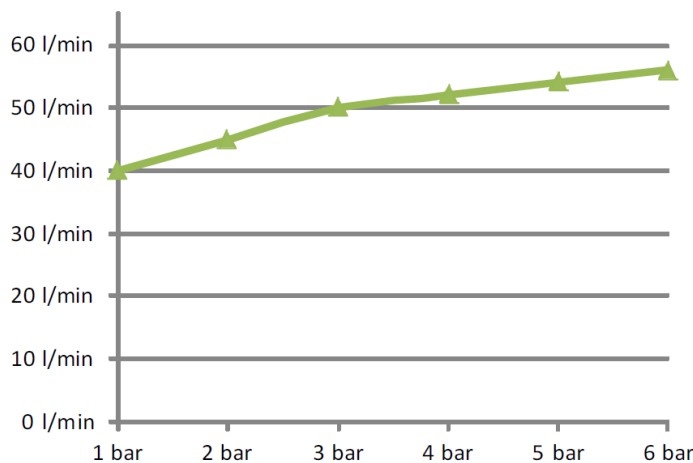

Référence EPCI	0210514-I
Longueur de col de cygne	400 mm
Hauteur totale	645 mm
Hauteur sous col de cygne	540 mm
Raccordement	G3/4
Débit d'eau	50 L (3 Bar)
Garantie	15 ans (corps inox)
Finition	Inox 316 L MAT