

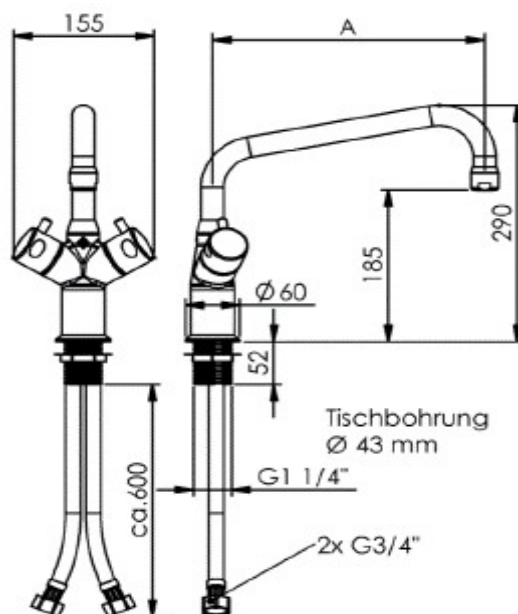

Robinet col de cygne 3/4" monotrou mélangeur
Inox 316L

Réf: 0210452-I



Fabrication Allemande



- Mélangeur à commande 1/4 tour
- Corps et tête de robinet en inox 316L
- Col de cygne avec système anti-goutte
- Poignée Thermo-isolante

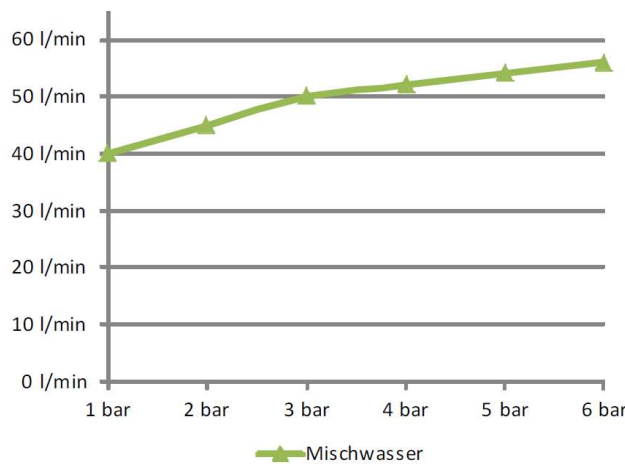

Référence EPCI	0210452-I
Longueur de col de cygne	A = 350 mm
Hauteur totale	290 mm
Hauteur sous col de cygne	185 mm
Raccordement	G3/4
Débit d'eau	50 L (3 Bar)
Garantie	15 ans (corps inox)
Finition	Inox 316 L MAT