

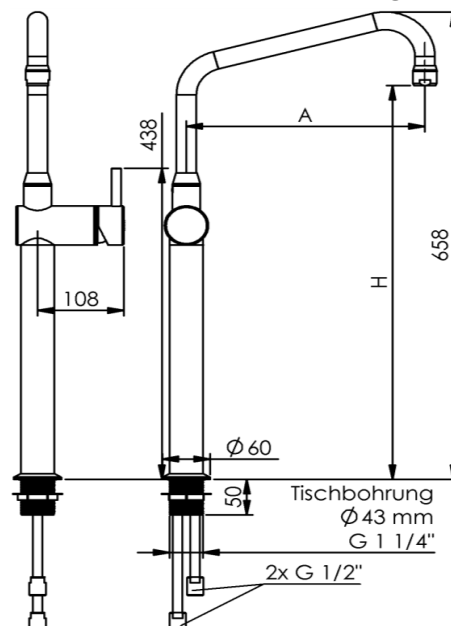

Robinet 3/4" monotrou mitigeur **Inox 316L**

Réf: 0210032-I



Fabrication Allemande



- Mitigeur à commande céramique avec butée de débit d'eau
- Corps et tête de robinet en inox 316L
- Col de cygne avec système anti-goutte
- Option : Assemblage par le dessus

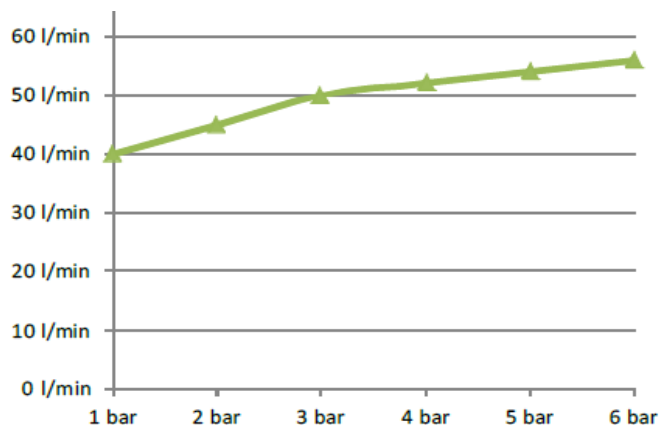
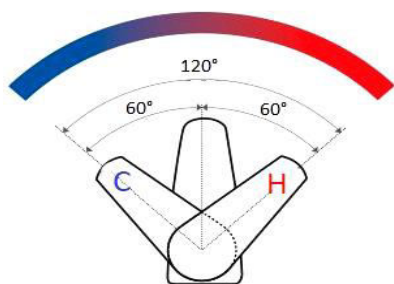

Référence EPCI	0210032-I
Longueur de col de cygne	A= 400 mm
Hauteur totale	658 mm
Hauteur sous col de cygne	H= 555 mm
Raccordement	G 1/2
Débit d'eau	50 L (3 Bar)
Finition	Inox 316L MAT
Garantie	15 ans (corps inox)