

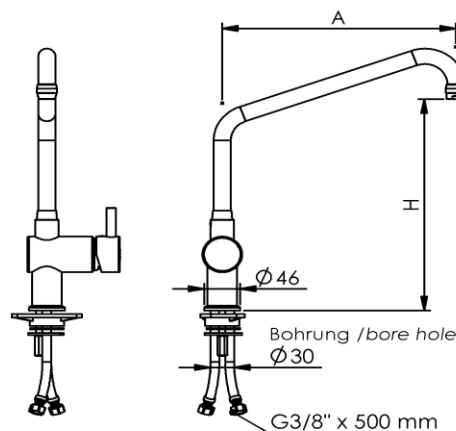

Robinet 1/2" monotrou mitigeur **Inox 316L**

Réf: 0210125-I



Fabrication Allemande



- Mitigeur à commande céramique à double position
Eco + Standard

- Corps et tête de robinet en inox 316L
- Col de cygne avec système anti-goutte
- Option : Assemblage par le dessus

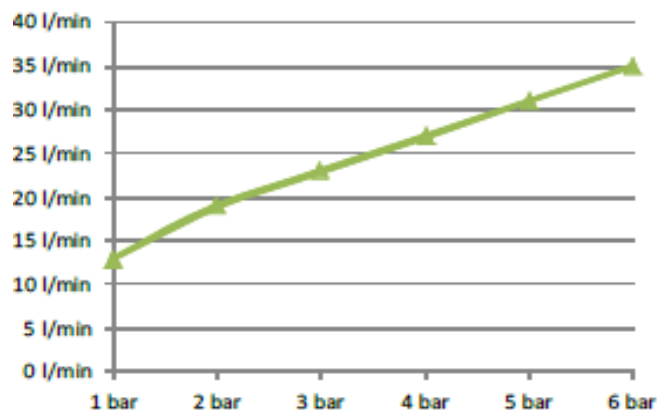
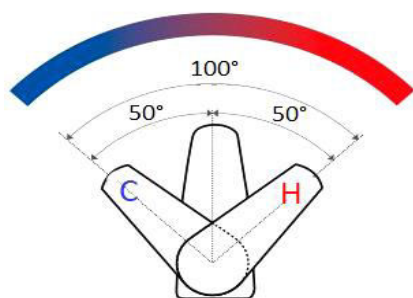

Référence EPCI	0210125-I
Longueur de col de cygne	A= 250 mm
Hauteur totale	385 mm
Hauteur sous col de cygne	H=300 mm
Raccordement	G 3/8 " x 500mm
Débit d'eau	23 L (3 Bar)
Finition	Inox 316L MAT