

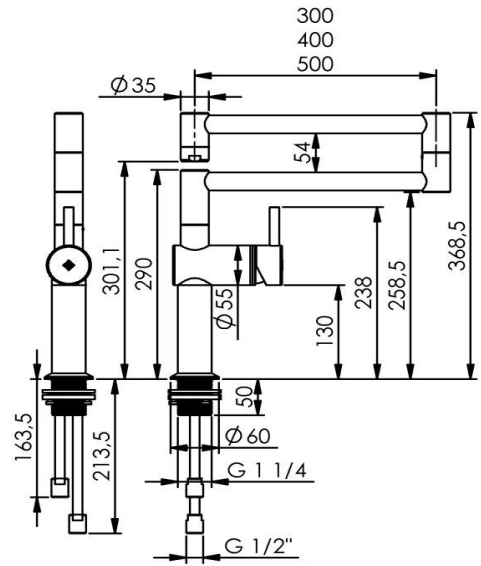

Robinet double col de cygne 3/4" monotrou mitigeur **Inox 316L**

Réf: 0210252-I



Fabrication Allemande



- Mitigeur à commande céramique avec butée de débit d'eau
- Corps et tête de robinet en inox 316L
- Col de cygne extensible et pivotant avec système anti-goutte
- Option : Assemblage par le dessus
- Disponible en 300+300 - 400+400 et 500+500 mm

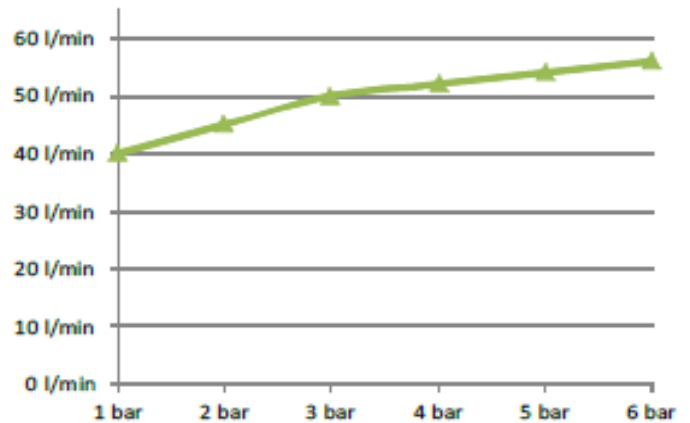
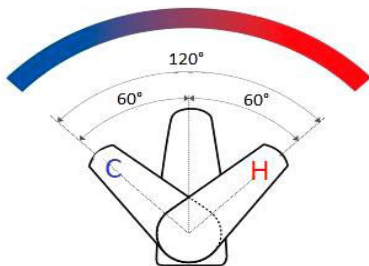

Référence EPCI	0210252-I
Longueur de col de cygne	500+500 mm
Hauteur totale	368,5 mm
Hauteur sous col de cygne	300 mm
Raccordement	G1/2
Débit d'eau	50 L (3 Bar)
Garantie	15 ans (corps inox)
Finition	Inox 316 L MAT